 <small>YAJIANG APPLIED TECHNOLOGIES</small>				图纸编号	RD-SS631-SM-04(SS-I)	版本号	B
SS631XCE MK3/MK4英文说明书				编制日期	2019.03.21		
制作	邓永杰	SSP	高文勇	审核		批准	
文件名及路径	系统文档夹/部门资料库/技术部/曾宪忠/包装设计/新方案/说明书/SilverStar/SS631XCE						
新物料编号	1320103030						
旧物料编号				成品编号	旧:P30264/新:1320100257		
通用产品							
备注	英文名称更改为CYAN 6000XCE MK3/MK4						H

5 APPENDIX

5.1 MAINTENANCE

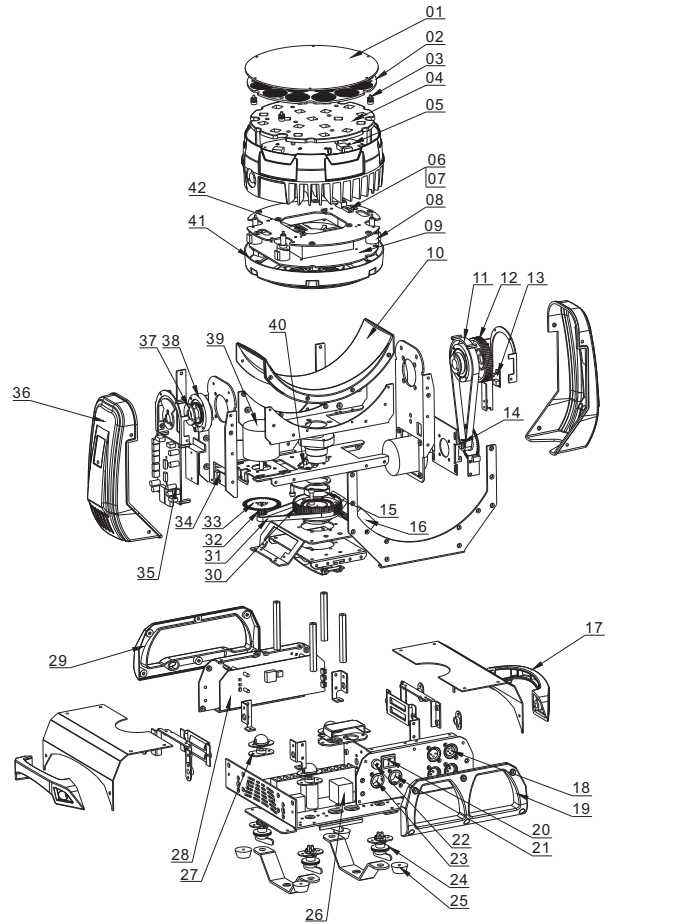

NO	Part name	NO	Part name	NO	Part name	NO	Part name
1	Head dustproof lens	11	Synchronous belt(Y axis)	21	PS socket (male)	31	Synchronous belt(X axis)
2	Focus lens(19 in I)	12	Y-large gear	22	Fuse holder	32	Y-small gear
3	Adjust pole	13	Magnetic stopper sensor(Y axis)	23	PS socket (male)	33	Optical wheel
4	Reflective bowl(19 in I)	14	Y axis small gear	24	Quick-lock	34	Optical stopper sensor
5	LED board	15	X axis baffle gasket	25	LT6 Enginery feet	35	Motor Driver board
6	Thermal switch holder	16	SUNON Fan(Base)	26	Power Supply	36	631 Plastic arm
7	Thermal switch	17	LED623 Handgrip	27	Quick-lock cushion	37	Y axis baffle gasket 1
8	Linear motor	18	Adaptor PCB	28	Display board	38	Y bearings combination
9	LED Driver board	19	Base box plastic cover(PS)	29	Base box plastic cover(Display)	39	Three-phase stepper motor
10	631 Plastic arm cover	20	Power switch	30	X bearings gear combination	40	Magnetic stopper sensor (X axis)
						41	Head plastic back cover
						42	Fan(Head)

CYAN 6000XCE MK3/MK4 USER MANUAL

® CYAN 6000XCE MK3/MK4
SS631

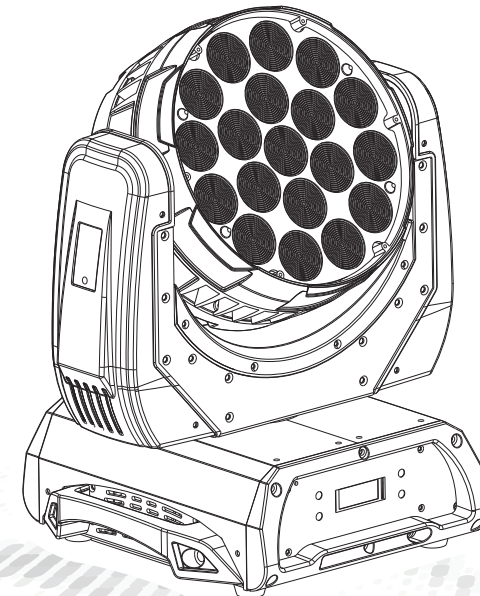

MODEL:SS631XCE MK3/MK4



广州市雅江光电设备有限公司

Guangzhou Yajiang Photoelectric Equipment Ltd.

电话/Tel : 020-86947788 邮箱/E-mail : sales@yajiang.cn

传真/Fax : 020-86943773 网址/Website : www.yajiang.cn

Since 1985

RD-SS631-SM-04(SS-1)

1 PRODUCT SPECIFICATIONS

1.1 PRODUCT SPECIFICATIONS

Electrical

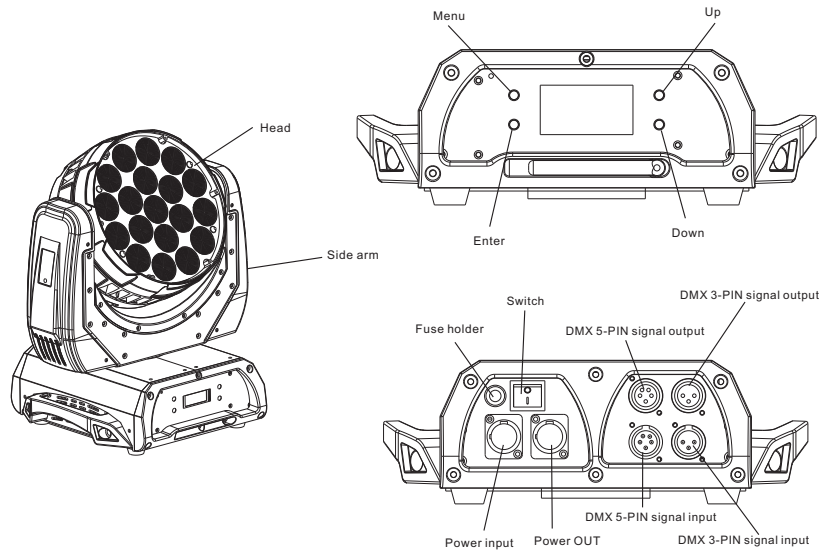

- ✓ Voltage: AC100~240V 50/60Hz
- ✓ Max Power: 350W
- ✓ Size: 338x270x341mm
- ✓ Weight: 10kg

1.2 PRODUCT FEATURES



CHANNEL	FUNCTION	VALUE	EFFECT
11	RED1	000 ↔ 255	RED1
12	RED1 FINE	000 ↔ 255	RED1 FINE
13	GREEN1	000 ↔ 255	GREEN1
14	GREEN1 FINE	000 ↔ 255	GREEN1 FINE
15	BLUE1	000 ↔ 255	BLUE1
16	BLUE1 FINE	000 ↔ 255	BLUE1 FINE
17	WHITE1	000 ↔ 255	WHITE1
18	WHITE1 FINE	000 ↔ 255	WHITE1 FINE
19	RED2U	000 ↔ 255	RED2U
20	RED2UFINE	000 ↔ 255	RED2UFINE
21	GREEN2U	000 ↔ 255	GREEN2U
22	GREEN2U FINE	000 ↔ 255	GREEN2U FINE
23	BLUE2U	000 ↔ 255	BLUE2U
24	BLUE2U FINE	000 ↔ 255	BLUE2U FINE
25	WHITE2U	000 ↔ 255	WHITE2U
26	WHITE2U FINE	000 ↔ 255	WHITE2U FINE
27	RED2D	000 ↔ 255	RED2D
28	RED2D FINE	000 ↔ 255	RED2D FINE
29	GREEN2D	000 ↔ 255	GREEN2D
30	GREEN2D FINE	000 ↔ 255	GREEN2D FINE
31	BLUE2D	000 ↔ 255	BLUE2D
32	BLUE2D FINE	000 ↔ 255	BLUE2D FINE
33	WHITE2D	000 ↔ 255	WHITE2D
34	WHITE2D FINE	000 ↔ 255	WHITE2D FINE

PERSON5

CHANNEL	FUNCTION	VALUE	EFFECT
1	PAN	000 ↔ 255	0~540 °
2	PAN FINE	000 ↔ 255	0~3 °
3	TILT	000 ↔ 255	0~270 °
4	TILT FINE	000 ↔ 255	0~3 °
5	PAN/TILT SPEED	000 ↔ 255	From fast to slow
6	DIMMER	000 ↔ 255	Dark to light 
7	DIMMER FINE	000 ↔ 255	Dark to light 
8	STROBE	000 ↔ 009 010 ↔ 255	NO function 1~20Hz
9	ZOOM	000 ↔ 255	Since the zoom 
10	CONTROL	000 ↔ 019 020 ↔ 039 040 ↔ 059 060 ↔ 079 080 ↔ 099 100 ↔ 119 120 ↔ 139 140 ↔ 149 150 ↔ 159 160 ↔ 169 170 ↔ 179 180 ↔ 199 200 ↔ 219 220 ↔ 235 236 ↔ 239 240 ↔ 243 244 ↔ 247 248 ↔ 251 252 ↔ 255	NO FUNCTION PAN/TILT BLACK ACTIVATED PAN/TILT BLACK DEACTIVATED FAN AUTO FAN SLOW FAN NORMAL FAN FAST AUTO1 AUTO2 TEST CUSTOM NO FUNCTION RESET NO FUNCTION DIM0 DIM1 DIM2 DIM3 DIM4

1.3 SAFETY WARNING

IMPORTANT!

This product must be installed by a qualified professional.
All maintenance must be carried out by a qualified electrician.
A minimum distance of 0.5m must be maintained between the equipment and a combustible surface.
The product must always be operated in a well ventilated area.
DO NOT stare directly into the LED light source.
Always disconnect the power before carrying out any maintenance.
The earth must always be connected to the ground.
Ensure that all parts of the equipment are kept clean and free of dust.

2 INSTALLATION

2.1 MOUNTING

The fixture can be mounted in any position.

Always ensure that mounting surface can withstand 10 times the weight of the fixture.

Always use a safety cable when mounting the fixture in any elevated position.

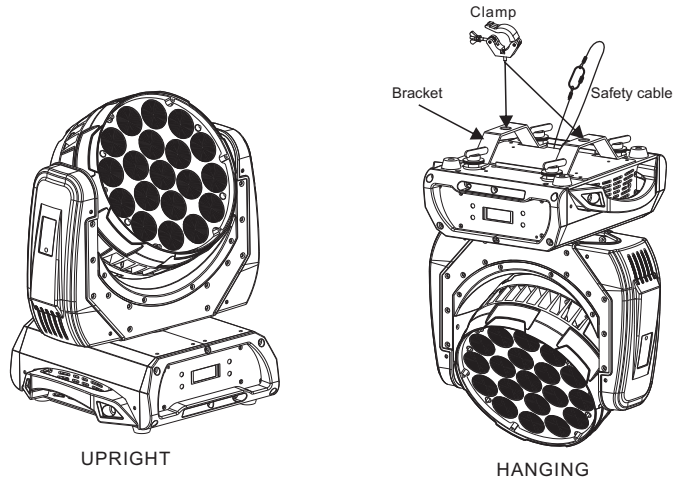

IMPORTANT SAFETY NOTE!!

Always use a safety cable when installing this unit!!

Be sure that the safety cable is connected to a solid load-bearing structure.

2.2 POWER CONNECTIONS



220~240V: 8 units may be connected in series



110~120V: 4 units may be connected in series

Note:

If the signal cable is over 60m between the DMX512 controller and fixture or between two fixtures, then a DMX signal amplifier is needed as well.

PERSON4

CHANNEL	FUNCTION	VALUE	EFFECT
1	PAN	000 ↔ 255	0~540°
2	PAN FINE	000 ↔ 255	0~3°
3	TILT	000 ↔ 255	0~270°
4	TILT FINE	000 ↔ 255	0~3°
5	PAN/TILT SPEED	000 ↔ 255	From fast to slow
6	DIMMER	000 ↔ 255	Dark to light 
7	STROBE	000 ↔ 009 010 ↔ 255	NO function 1~20Hz
8	ZOOM	000 ↔ 255	Since the zoom 
9	CONTROL	000 ↔ 019 020 ↔ 039 040 ↔ 059 060 ↔ 079 080 ↔ 099 100 ↔ 119 120 ↔ 139 140 ↔ 149 150 ↔ 159 160 ↔ 169 170 ↔ 179 180 ↔ 199 200 ↔ 219 220 ↔ 235 236 ↔ 239 240 ↔ 243 244 ↔ 247 248 ↔ 251 252 ↔ 255	NO FUNCTION PAN/TILT BLACK ACTIVATED PAN/TILT BLACK DEACTIVATED FAN AUTO FAN SLOW FAN NORMAL FAN FAST AUTO1 AUTO2 TEST CUSTOM NO FUNCTION RESET NO FUNCTION DIM0 DIM1 DIM2 DIM3 DIM4
10	RED1	000 ↔ 255	RED1
11	GREEN1	000 ↔ 255	GREEN1
12	BLUE1	000 ↔ 255	BLUE1
13	WHITE1	000 ↔ 255	WHITE1
14	RED2U	000 ↔ 255	RED2U
15	GREEN2U	000 ↔ 255	GREEN2U
16	BLUE2U	000 ↔ 255	BLUE2U
17	WHITE2U	000 ↔ 255	WHITE2U
18	RED2D	000 ↔ 255	RED2D
19	GREEN2D	000 ↔ 255	GREEN2D
20	BLUE2D	000 ↔ 255	BLUE2D
21	WHITE2D	000 ↔ 255	WHITE2D

CHANNEL	FUNCTION	VALUE	EFFECT
1	PAN	000 ↔ 255	0-540
2	TILT	000 ↔ 255	0-270
3	HUE	000 ↔ 255	HUE
4	SATURATION	000 ↔ 255	SATURATION
5	VALUE	000 ↔ 255	VALUE
6	STROBE	000 ↔ 009 010 ↔ 255	NO function 1-20Hz
7	ZOOM	000 ↔ 255	Since the zoom  
8	CONTROL	000 ↔ 019 020 ↔ 039 040 ↔ 059 060 ↔ 079 080 ↔ 099 100 ↔ 119 120 ↔ 139 140 ↔ 149 150 ↔ 159 160 ↔ 169 170 ↔ 179 180 ↔ 199 200 ↔ 219 220 ↔ 235 236 ↔ 239 240 ↔ 243 244 ↔ 247 248 ↔ 251 252 ↔ 255	NO FUNCTION PAN/TILT BLACK ACTIVATED PAN/TILT BLACK DEACTIVATED FAN AUTO FAN SLOW FAN NORMAL FAN FAST AUTO1 AUTO2 TEST CUSTOM NO FUNCTION RESET NO FUNCTION DIM0 DIM1 DIM2 DIM3 DIM4

2.3 FUSE REPLACEMENT

Remove the safety cap by a screwdriver.
 Fetch the old fuse from safety cap.
 Install a new fuse.
 Install the safety cap.

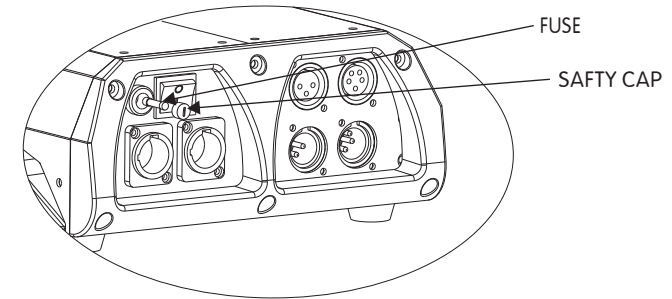

3 DISPLAY PANEL OPERATION

3.1 DISPLAY OPERATION

- √ MENU ← BACK
- √ ENTER ← ENTER OR SAVE
- √ DOWN ← DOWN
- √ UP ← UP

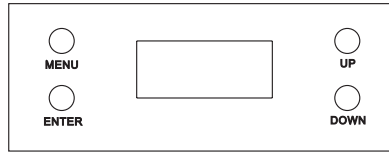

3.2 MENU MAP

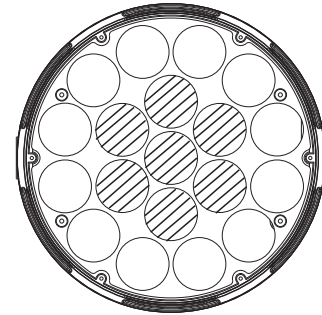
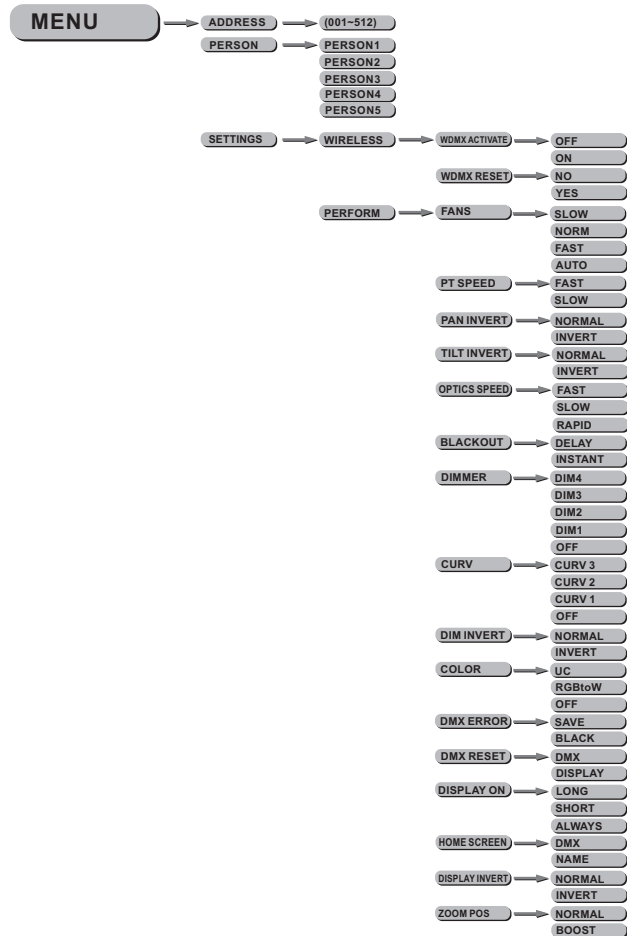

RING 1

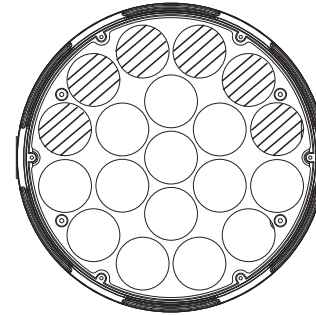

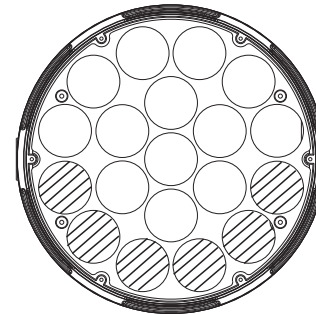

RING 2D



RING 2U

To identify up, middle and down by head which after the fixture electrify & reset

CHANNEL	FUNCTION	VALUE	EFFECT
15	AUTO RINGS	000 ⇔ 009	ALL RINGS
		010 ⇔ 019	STATIC RING 1
		020 ⇔ 029	STATIC RING 2u
		030 ⇔ 039	STATIC RING 2d
		040 ⇔ 049	RING EFFECT 1: FILL centre-out with black (1, 1+2u+2d, 0)
		050 ⇔ 059	RING EFFECT 2: FILL out-centre with black (2u+2d+1, 1, 0)
		060 ⇔ 069	RING EFFECT 3: RING centre-out with black (1, 2u+2d, 0)
		070 ⇔ 079	RING EFFECT 4: RING out-centre with black (2u+2d, 1, 0)
		080 ⇔ 089	RING EFFECT 5: DOT-FILL centre-out with black (1, 0, 1+2U+2d, 0)
		090 ⇔ 099	RING EFFECT 6: DOT-FILL out-centre with black (1+2u+2d, 0, 1, 0)
		100 ⇔ 109	RING EFFECT 7: DOT STROBE (1, 0)
		110 ⇔ 119	RING EFFECT 8: RING STROBE (2u+2d, 0)
		120 ⇔ 129	RING EFFECT 9: LINES ONEWAY (2u, 1, 2d)
		130 ⇔ 139	RING EFFECT 10: LINES ONEWAY with black (2u, 1, 2d, 0)
		140 ⇔ 149	RING EFFECT 11: LINES TWOWAY (2u, 1, 2d, 2d, 1, 2u)
		150 ⇔ 159	RING EFFECT 12: LINES TWOWAY with black (2u, 1, 2d, 2d, 1, 2u, 0)
		160 ⇔ 169	RING EFFECT 13: OPPOSITE LINE (2u, 2d)
		170 ⇔ 179	RING EFFECT 14: OPPOSITE ring with black (2u, 2d, 0)
		180 ⇔ 189	STATIC RING WITH COLOR 1: (1=green, 2u+2d=red)
		190 ⇔ 199	STATIC RING WITH COLOR 2: (1=blue, 2u+2d=red)
		200 ⇔ 209	STATIC RING WITH COLOR 3: (1=white, 2u+2d=red)
		210 ⇔ 219	STATIC RING WITH COLOR 4: (1=red, 2u+2d=blue)
		220 ⇔ 229	STATIC RING WITH COLOR 5: (1=green, 2u+2d=blue)
		230 ⇔ 239	STATIC RING WITH COLOR 6: (1=white, 2u+2d=blue)
		240 ⇔ 249	STATIC RING WITH COLOR 6: (1=white, 2u+2d=blue)
250 ⇔ 255	ALL RINGS		
16	AUTO SPEED	000 ⇔ 255	Slow to fast
17	DIMMER	000 ⇔ 255	Dark to light 
18	DIMMER FINE	000 ⇔ 255	Dark to light 
19	STROBE	000 ⇔ 009 010 ⇔ 255	NO function 1~20Hz
20	ZOOM	000 ⇔ 255	Since the zoom 
21	CONTROL	000 ⇔ 019	NO FUNCTION
		020 ⇔ 039	PAN/TILT BLACK ACTIVATED
		040 ⇔ 059	PAN/TILT BLACK DEACTIVATED
		060 ⇔ 079	FAN AUTO
		080 ⇔ 099	FAN SLOW
		100 ⇔ 119	FAN NORMAL
		120 ⇔ 139	FAN FAST
		140 ⇔ 149	AUTO1
		150 ⇔ 159	AUTO2
		160 ⇔ 169	TEST
		170 ⇔ 179	CUSTOM
		180 ⇔ 199	NO FUNCTION
		200 ⇔ 219	RESET
		220 ⇔ 235	NO FUNCTION
		236 ⇔ 239	DIM0
		240 ⇔ 243	DIM1
		244 ⇔ 247	DIM2
		248 ⇔ 251	DIM3
		252 ⇔ 255	DIM4

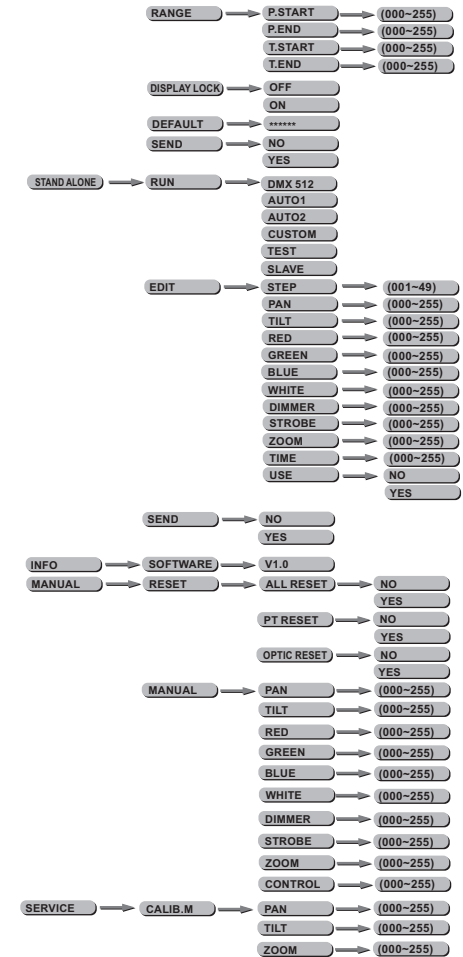

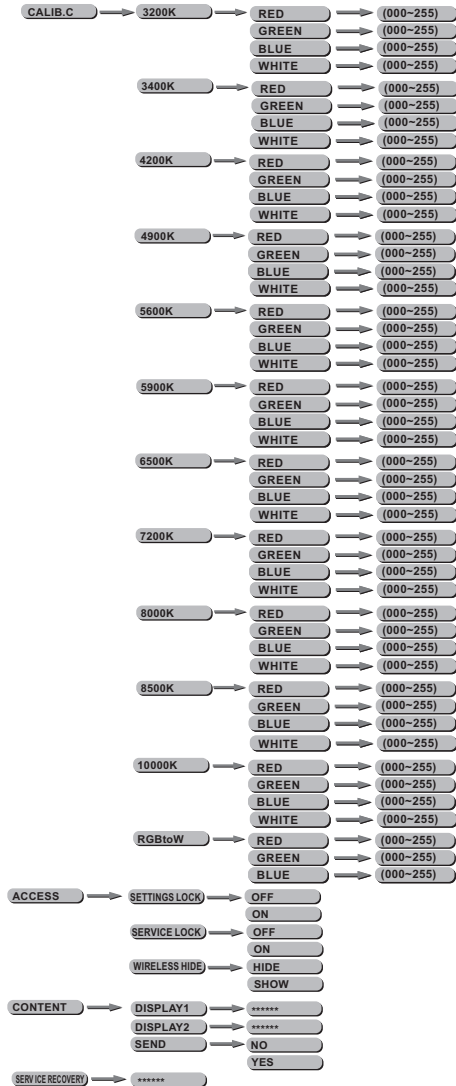

PERSON2



CHANNEL	FUNCTION	VALUE	EFFECT
1	PAN	000 ↔ 255	0~540°
2	PAN FINE	000 ↔ 255	0~3°
3	TILT	000 ↔ 255	0~270°
4	TILT FINE	000 ↔ 255	0~3°
5	PAN/TILT SPEED	000 ↔ 255	From fast to slow
6	RED	000 ↔ 255	RED
7	RED FINE	000 ↔ 255	RED FINE
8	GREEN	000 ↔ 255	GREEN
9	GREEN FINE	000 ↔ 255	GREEN FINE
10	BLUE	000 ↔ 255	BLUE
11	BLUE FINE	000 ↔ 255	BLUE FINE
12	WHITE	000 ↔ 255	WHITE
13	WHITE FINE	000 ↔ 255	WHITE FINE
14	COLOR/ WHITE MACRO	000 ↔ 005 NO FUCNTION 006 ↔ 010 NO FUCNTION 011 ↔ 030 RED 100% / GREEN UP / BLUE 0% 031 ↔ 050 RED DOWN / GREEN 100% / BLUE 0% 051 ↔ 070 RED 0% / GREEN 100% / BLUE UP 071 ↔ 090 RED 0% / GREEN DOWN / BLUE 100% 091 ↔ 110 RED UP / GREEN 0% / BLUE 100% 111 ↔ 130 RED 100% / GREEN 0% / BLUE DOWN 131 ↔ 150 RED 100% / GREEN UP / BLUE UP 151 ↔ 170 RED DOWN / GREEN DOWN / BLUE 100% 171 ↔ 200 RED 100% / GREEN 100% / BLUE 100% / WHITE 100% 201 ↔ 205 WHITE1: 3200K 206 ↔ 210 WHITE2: 3400K 211 ↔ 215 WHITE3: 4200K 216 ↔ 220 WHITE4: 4900K 221 ↔ 225 WHITE5: 5600K 226 ↔ 230 WHITE6: 5900K 231 ↔ 235 WHITE7: 6500K 236 ↔ 240 WHITE8: 7200K 241 ↔ 245 WHITE9: 8000K 246 ↔ 250 WHITE10: 8500K 251 ↔ 255 WHITE11: 10000K	

4 USING A DMX512 CONTROLLER

4.1 CHANNEL ASSIGNMENT

Note: This product have five DMX512 channel configuration:
PERSON1 | PERSON2 | PERSON3 PERSON4
and **PERSON5** .

PERSON1

CHANNEL	FUNCTION	VALUE	EFFECT
1	PAN	000 ↔ 255	0~540
2	TILT	000 ↔ 255	0~270
3	RED	000 ↔ 255	RED
4	GREEN	000 ↔ 255	GREEN
5	BLUE	000 ↔ 255	BLUE
6	WHITE	000 ↔ 255	WHITE
7	DIMMER	000 ↔ 255	Dark to light 
8	STROBE	000 ↔ 009 010 ↔ 255	NO function 1~20Hz
9	ZOOM	000 ↔ 255	Since the zoom 
10	CONTROL	000 ↔ 019 020 ↔ 039 040 ↔ 059 060 ↔ 079 080 ↔ 099 100 ↔ 119 120 ↔ 139 140 ↔ 149 150 ↔ 159 160 ↔ 169 170 ↔ 179 180 ↔ 199 200 ↔ 219 220 ↔ 235 236 ↔ 239 240 ↔ 243 244 ↔ 247 248 ↔ 251 252 ↔ 255	NO FUNCTION PAN/TILT BLACK ACTIVATED PAN/TILT BLACK DEACTIVATED FAN AUTO FAN SLOW FAN NORMAL FAN FAST AUTO1 AUTO2 TEST CUSTOM NO FUNCTION RESET NO FUNCTION DIM0 DIM1 DIM2 DIM3 DIM4

3.3 DMX512 SETTINGS

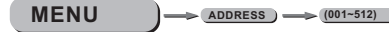

Enter the DMX mode to set the DMX ADDRESS.

3.4 PERSONALITY



Enter the PERSONALITY mode to select DMX mode: PERSON1 ,
PERSON2 , PERSON3 , PERSON4 , PERSON5 .

3.51 DATA

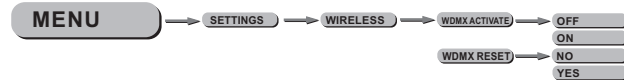

Select DATA from the SETTINGS menu.
WDMX ACTIVATE menu, select ON/OFF for WDMX activation
WDMX RESET menu, select NO/YES for resetting the WDMX function.
Please note that a fixture must be reset before it can be paired with a new WDMX transmitter.

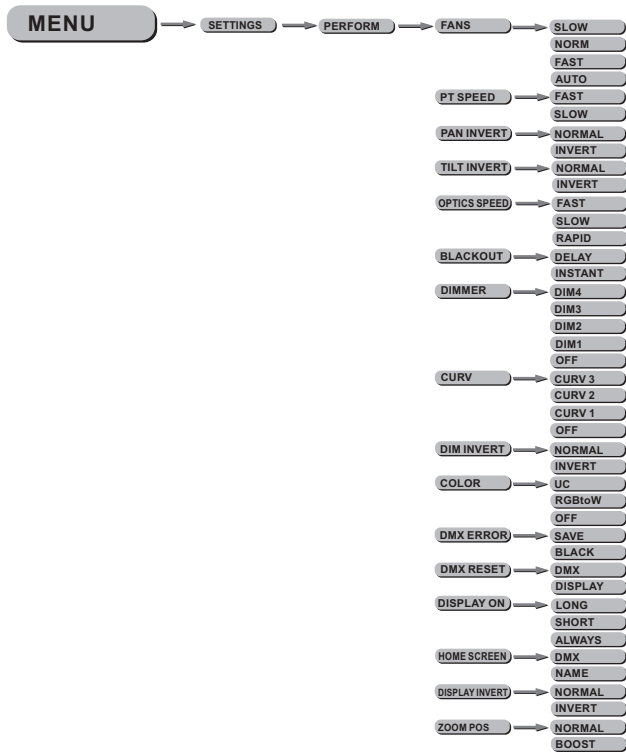

Select PERFORM from the SETTINGS menu.

FANS menu, select Slow/Norm/Fast/Auto as required fan speed.

PT SPEED menu, select Slow/Fast as required PAN/TILT movement speed.

PAN INVERT menu, select NORM/INVERT for normal/inverted control of the PAN function

TILT INVERT menu, select NORM/INVERT for normal/inverted control of the TILT function

OPTICS SPEED menu, select SLOW/FAST/RAPID optics speed

BLACKOUT menu, select INSTANT for immediate activation of PAN/TILT blackout when selected using the control channel or DELAY for 3 second delay before activation. DIMMER menu for selection of

DIM1/DIM2/DIM3/DIM4/OFF special dimming curves

CURV allows the user to adjust the shape of the dimming curve. See the CURV chart to understand more about actual dimming curves.

DIM INVERT menu, select NORMAL/INVERT for normal/inverted control of DIMMING function

3.8 ACCESS

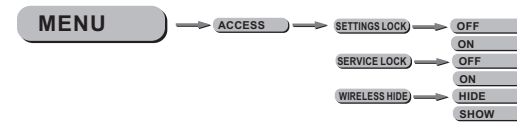

Select ACCESS from the SERVICE menu

SETTINGS LOCK menu, select OFF/ON to enable access to SETTINGS menu

SERVICE LOCK menu, select OFF/ON to enable access to SERVICE menu

WIRELESS HIDE menu, select HIDE/SHOW to show wireless options in settings menu

3.9 CONTENT



Select CONTENT from the SERVICE menu

DISPLAY 1 menu, edit first line of display content

DISPLAY 2 menu, edit second line of display content

SEND menu, select YES in order to transfer display content to all fixtures currently connected via data cable

3.10 SERVICE



- In order to reset custom modes to default values select [REST] .

3.66 CALIB.M

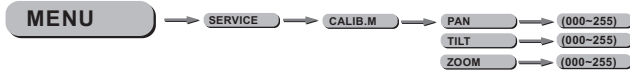

Select CALIB.M from the SERVICE menu in order to calibrate the motors
Adjust the values of the PAN/TILT/ZOOM motors in order to calibrate the start motor position

3.7 CALIB

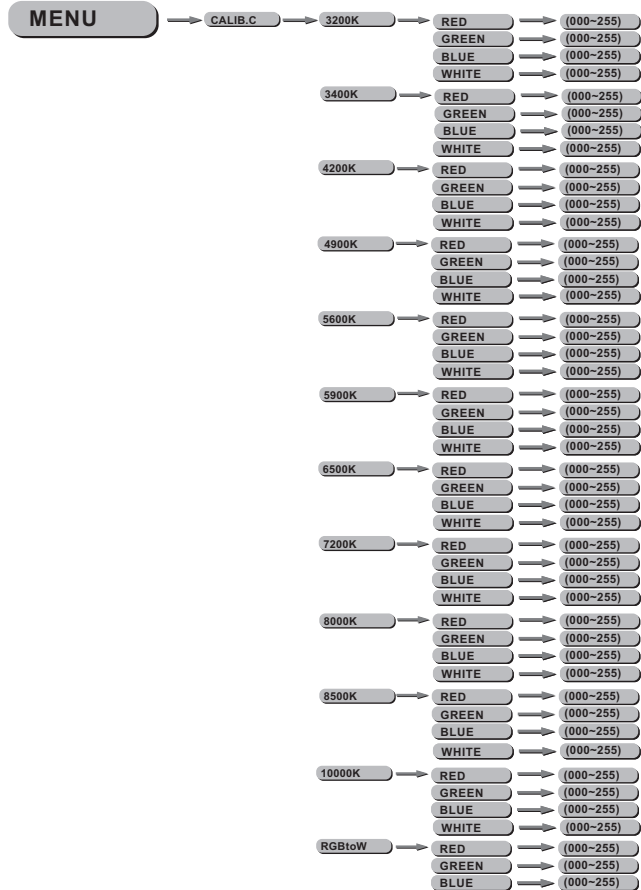

Enter the Calib. to select white color of different color temperature.
There are 11 pre-programmed White colors plus RGB TO WHITE and can be edited by using Red, Green, Blue & White.

COLOR is for activate/unactivate the color calibration functions. When [RGBtoW] is selected, on RGB = 255,255,255, the color is displayed as calibrated in CAL2 -- RGBW. When [COLOR] is set [OFF], on RGB = 255,255,255, the RGB values are not adjusted and the output is most powerful. When [UC] is selected, the RGB output are adjusted to a standard preset universal color which balances fixtures from different generations.

DMXerror menu, select SAVE to maintain last command in case of DMX error or BLACK for blackout

DMXreset menu, select DMX to allow remote reset using DMX controller or DISPLAY for reset only available at on-fixture display

DISPLAY ON menu, select LONG/SHORT/ALWAYS for length of time for display backlight

HOME SCREEN menu, select DMX to display DMX address or NAME for product/manufacturer name

Display Invert menu, select NORMAL/INVERT display direction

Zoom pos menu, select NORMAL/INVERT display direction

3.53 INVERT



Select P.start / P.end / T.start / T.end to which is from (001-512)

3.54 DISPLAY LOCK



Choose the Display lock key lock Settings

3.55 DEFAULT



This functions will reset all setting to the original factory setting



Select SEND from the SETTINGS menu in order to send all settings to all fixtures currently linked via data cable

3.61 RUN

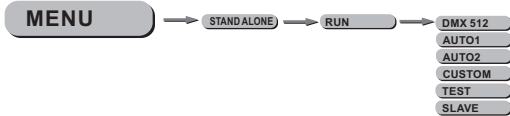

Enter the STAND ALONE menu to select from AUTO 1/AUTO 2/CUSTOM/TEST/SLAVE run modes

3.62 EDIT

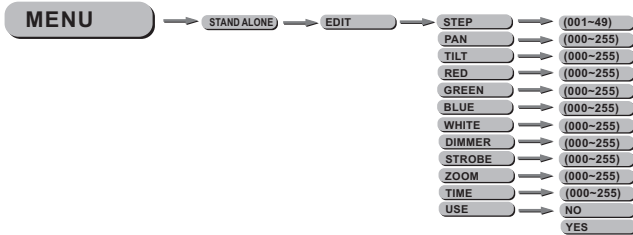

Enter the Edit mode to edit the custom programs by adjusting the value of Step , Pan , Tilt , Red , Green , Blue , White , Dimmer , Strobe , Zoom , Time
 Enter Use and select Yes to run the steps user need.

Note: if user want to circulate the created steps, please set the last step s Time as 0

For example, there are 3 steps, the setting should be like belowed:
 Step1 Time = 4 Use = Yes
 Step2 Time = 5 Use = Yes
 Step3 Time = 0 Use = Yes

3.63 SEND



Select SEND, from the STAND ALONE menu to send the CUSTOM program to all fixtures currently linked via data cable

3.64 INFO



Select INFO from the Stand alone menu in order to view the Software version UID number

3.65(1) MANUAL

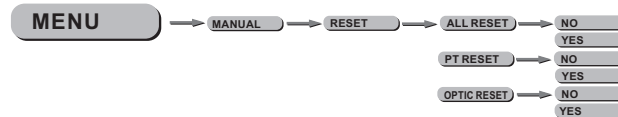

Select RESET from the MANUAL menu
 ALL RESET menu, select YES/NO to carry out full fixture reset
 PT RESET menu, select YES/NO to carry out PAN/TILT reset
 OPTIC RESET menu, select YES/NO to carry out OPTIC reset

3.65(2) MANUAL

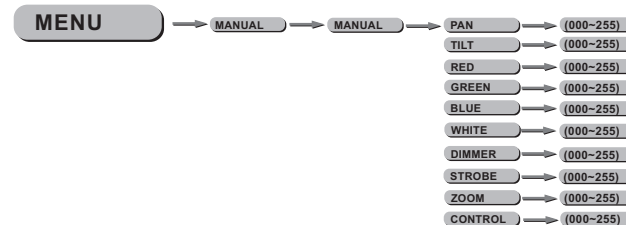

Select MANUAL from the MANUAL menu
 Adjust the values of PAN/TILT/RED/GREEN/BLUE/WHITE/DIMMER/STROBE/ZOOM in order to carry out manual control