

TARPON 84Q X

USER MANUAL

arctik® TARPON 84Q X
ARCHITECTURAL TECHNOLOGY AM1393

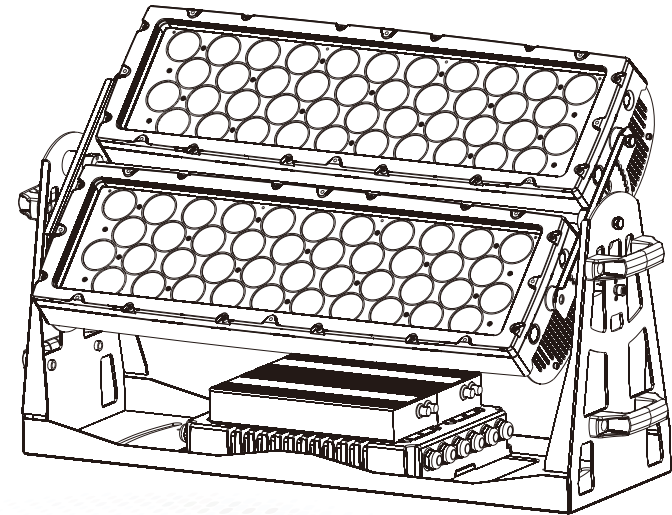

MODEL:AM1393XLET



广州市雅江光电设备有限公司

Guangzhou Yajiang Photoelectric Equipment Ltd.

电话/Tel : 020-86947788 邮箱/E-mail : sales@yajiang.cn

传真/Fax : 020-86943773 网址/Website : www.yajiang.cn

Since 1985

RD-AM1393-SM-01(ARC-I)

1 Product Introduction

1.1 Specification

Product Code	AM1393XLET
Dimension	881 × 252 × 569(mm)
Weight	45.3KG
Rated Power	1200W
Input Voltage	AC163~305V
Frequency Range	50/60Hz
Protection Grade	IP67
Ambient Temperature	-20℃~45℃
LED quantity	R/G/B/LX84pcs
Control Model	DMX512/RDM

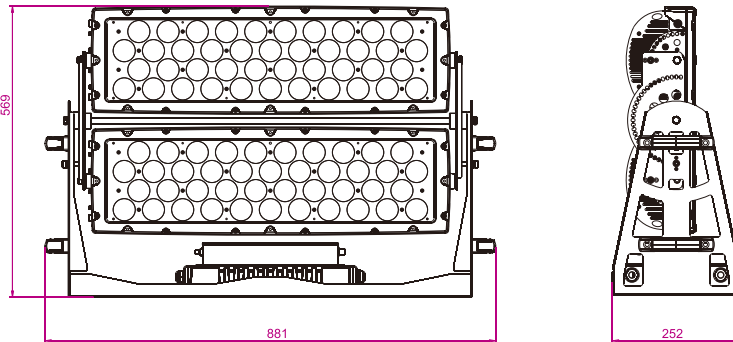

4.11 UC-CALIB



- Find the menu 【UC-CALIB】 and press 【ENTER】 to set the red/green/blue of UC.
- Press 【DOWN】 or 【UP】 to modify the value 【0~255】 of 【RED】 / 【GREEN】 / 【BLUE】 ,then press 【ENTER】 to send to save.

4.12 Settings

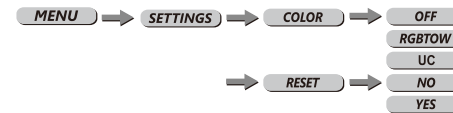

- When 【RGB TO W】 is set to 【YES】 , the color is perfect white as the actual RGB values are adjusted to make white. When it is set to 【OFF】 ,the RGB values are not adjusted and the output is most powerful. The 【RGB TO W】 ' s parameter can be adjusted in 【CALIB】 .
- 【UC】 Function can compatible with the older version 【RGB】 to make color consistency.
- Enter the 【RESET】 , pass 【YES】 to reset all setting to the original factory setting

4.8 Personality

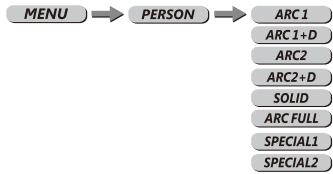

- Enter [PERSON] and select [ARC1] / [ARC1+D] / [ARC2] / [ARC2+D] / [SOLID] / [ARC FULL] / [SPECIAL 1] / [SPECIAL 2] mode, press [Enter]
- When selecting [ARC 1] / [ARC1+D] / [ARC2] / [ARC2+D] / [SOLID] / [ARC FULL] / [SPECIAL 1] / [SPECIAL 2] , the fixture is under the DMX work mode.

4.9 DMX address



- Enter the [DMX] mode to set the DMX address, press [Enter] .
- On successful setting, the fixtures will display Green and turn off after ten seconds.
- If an error occurs when setting, the fixtures will display Red or no response.

4.10 CS_SET CCT correction

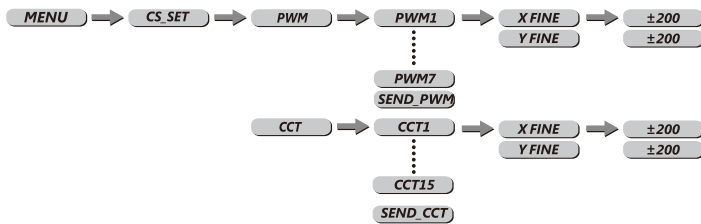

- Long press the “POWER” to start up. After starting up, select “CCS_SET” menu, press “ENTER” to enter the menu “CCT” . Inside the menu “CCT” of AM700,select “CCT1~CCT15” and input the value of “X FINE” and “Y FINE” for the each CCT parameter. The rest “CCT*” (* stands for Arabic numerals) in AM700, if any, input “0” for all the rest “CCT*” ;With above setting, again inside the AM700 menu “CCT” , select the “SEND CCT” to transmit the 1800K~10000K parameter to lighting fixtures.
- The operation method of “SEND PWM” is the same as above

1.2 Safety warning

IMPORTANT

Always read the user manual before operation.
Please confirm that the power supply stated on the product is the same as the mains power supply in your area.

- This product must be installed by a qualified professional.
- Always operate the equipment as described in the user manual.
- A minimum distance of 0.5m must be maintained between the equipment and combustible surface.
- The product must always be placed in a well ventilated area.
- Always make sure that the equipment is installed securely.
- Do not stand close to the equipment and stare directly into the LED light source.
- Always disconnect the power supply before attempting and maintenance.
- Always make sure that the supporting structure is solid and can support the combined weight of the products.
- The earth wire must always be connected to the ground.
- Do not touch the power cables if your hands are wet.

ATTENTION



- This product left the place of manufacture in perfect condition. In order to maintain this condition and for safe operation, the user must always follow the instructions and safety warnings described in this user manual.
- Avoid shaking or strong impacts to any part of the equipment.
- Make sure that all parts of the equipment are kept clean and free of dust.
- Always make sure that the power connections are connected correct and secure.
- If there is any malfunction of the equipment, contact your distributor immediately.
- When transferring the product, it is advisable to use the original packaging in which the product left the factory.
- Shields, lenses or ultraviolet screens shall be changed if they have become damaged to such an extent that their effectiveness is impaired.
- The lamp (LED) shall be changed if it has become damaged or thermally deformed.



Caution, risk of electric shock
The light source contained in this luminaire shall only be replaced by the manufacturer or his service agent or a similar qualified person.

2 Installation

2.1 Mounting

The fixture can be mounted in any position. Always ensure that mounting surface can withstand 10 times the weight of the fixture.

Always use a safety cable when mounting the fixture in any elevated position.

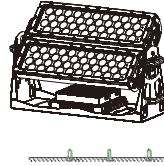

2.2 Power connections

This product provides for the use of input power and signal cables are three-core, the connection diagram is as follows

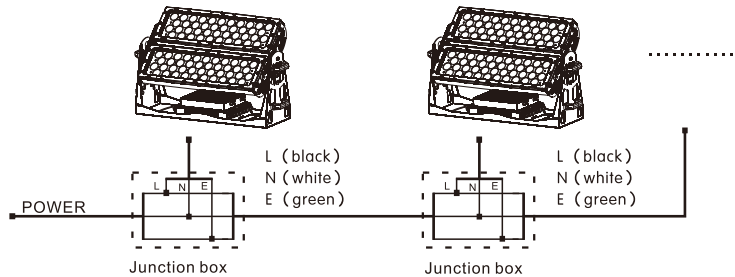

2.3 Signal connections

If the signal cable is over 60m between the DMX512 controller and fixture or between two fixtures, then a DMX signal amplifier is needed as well.

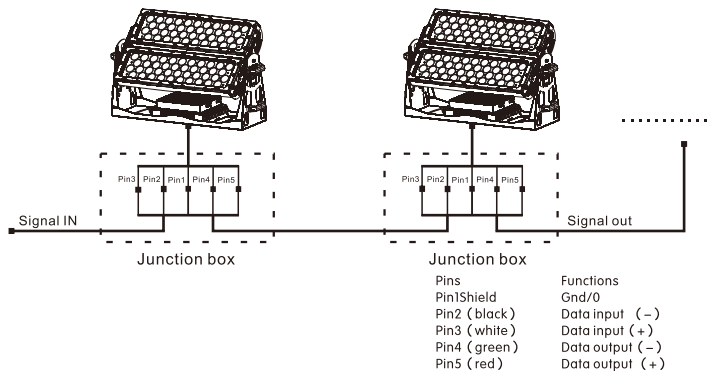

4.5 Static

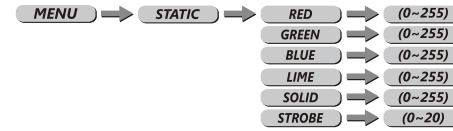

- Enter the 【STATIC】 mode to create the programs
- Combine 【RED】 , 【GREEN】 , 【BLUE】 , 【LIME】 , 【SOLID】 and 【STROBE】 to create an infinite range of colors.
- Set the value of the 【STROBE】 【0-20Hz】
- The static setting will be valid when the fixture is powered again

4.6 Dimmer

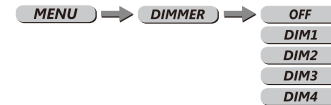

- Enter the 【DIMMER】 to select the dimmer work mode, press 【Enter】
- When Dimmer is set to 【OFF】 the RGB and Master Dimmer are linear,
- When selecting 【DIM1】 , 【DIM2】 , 【DIM3】 or 【DIM4】 ,the RGB and Master Dimmer are nonlinear.
- These4 dimming modes have different soft and smooth dimming effects from fast to slow.

4.7 Calibration

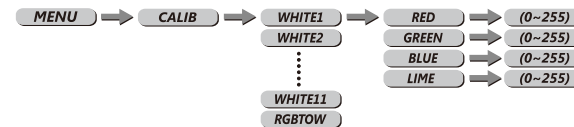

- Enter the 【CALIB】 to select white colors of different color temperature
- There are 11 pre-programmed white colors plus RGB and can be edited by using 【Red】 , 【Green】 , 【Blue】 or 【Lime】 ,press 【Enter】 to set the values
- Select 【RGB TOW】 to set the ratio of 【Red】 , 【Green】 , and 【Blue】 on DMX channels, achieving different white colors.

4.4 MENU

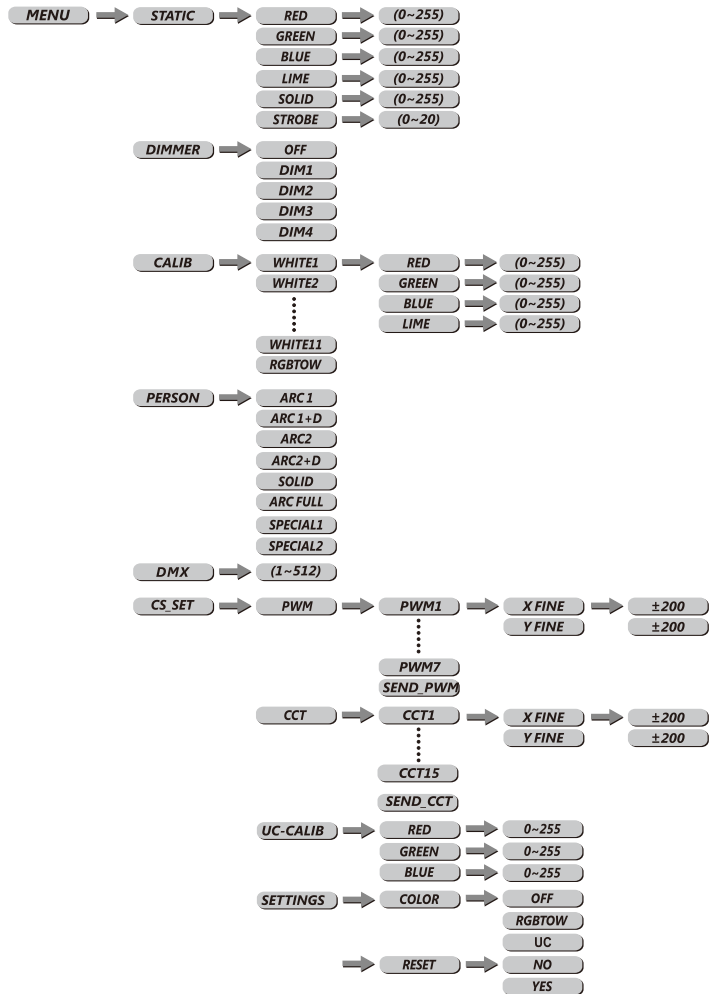

3 Control with a DMX512 controller

3.1 Channel assignment

Note: This product has eight DMX512 channel configurations:

[ARC1], [ARC1+D], [ARC2], [ARC2+D], [SOLID], [ARCFULL], [SPECIAL1] and [SPECIAL2].

ARC 1

CHANNEL	VALUE	FUNCTION
1	000 ↔ 255	RED
2	000 ↔ 255	GREEN
3	000 ↔ 255	BLUE

ARC 1+D

CHANNEL	VALUE	FUNCTION
1	000 ↔ 255	MASTER DIMMER
2	000 ↔ 255	RED
3	000 ↔ 255	GREEN
4	000 ↔ 255	BLUE

ARC 2

CHANNEL	VALUE	FUNCTION
1	000 ↔ 255	RED
2	000 ↔ 255	GREEN
3	000 ↔ 255	BLUE
4	000 ↔ 255	LIME

ARC 2+D

CHANNEL	VALUE	FUNCTION
1	000 ↔ 255	MASTER DIMMER
2	000 ↔ 255	RED
3	000 ↔ 255	GREEN
4	000 ↔ 255	BLUE
5	000 ↔ 255	LIME

SOLID

CHANNEL	VALUE	FUNCTION
1	000 ↔ 255	CONTROL ALL LED

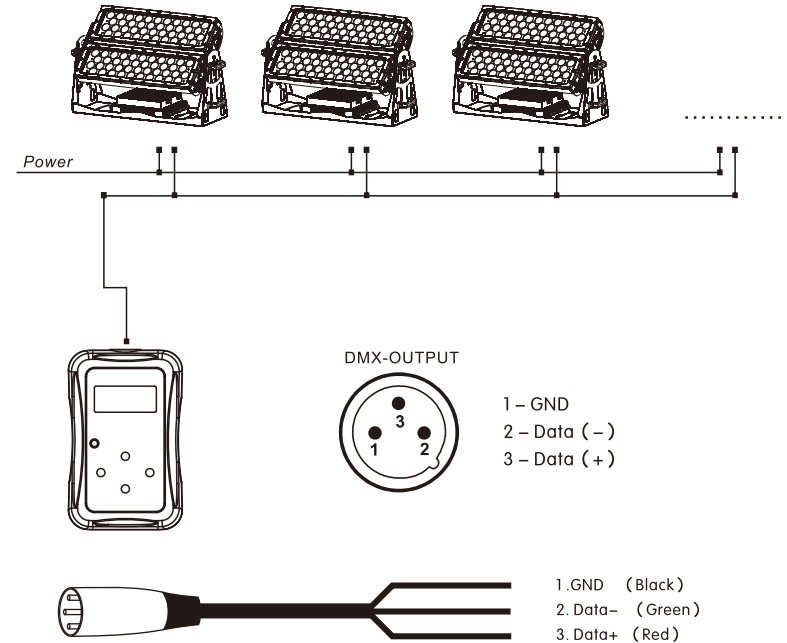

Signal Connector

Note:
The DMX Coder will automatically power off after extended periods of being idle(1 minute)

4.3 Display operation

- [POWER] Power on
- [MENU] Scroll through the main menu or exit from the current sub-menu (press and hold to turn off power).
- [ENTER] Enter the currently selected menu or confirm the current function value.
- [DOWN] Scroll 'DOWN' through the menu list or decrease the value of the current function.
- [UP] Scroll 'UP' through the menu list or increase the value of the current function.

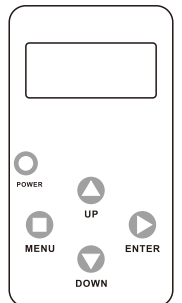

4 Using the DMX coder

4.1 Technical specifications

Battery: 2 x 1.5V AA

Weight: 0.2kg

Dimensions: 110x70x28mm

4.2 Setting parameters

Connect the DMX coder to the units in series.

Set the DMX address, Personality, Calibration and Dimmer of fixtures through the DMX coder.

A maximum of 20 units in series can be set by the DMX coder at the same time.

All connected units will be set with the same information.

ARC FULL

CHANNEL	VALUE	FUNCTION
1	000 ↔ 255	MASTER DIMMER
2	000 ↔ 255	RED
3	000 ↔ 255	GREEN
4	000 ↔ 255	BLUE
5	000 ↔ 010	NO FUNCTION
	011 ↔ 030	RED 100%/GREEN UP/BLUE 0%
	031 ↔ 050	RED DOWN/GREEN 100%/BLUE 0%
	051 ↔ 070	RED 0%/GREEN 100%/BLUE UP
	071 ↔ 090	RED 0%/GREEN DOWN/BLUE 100%
	091 ↔ 110	RED UP/GREEN 0%/BLUE 100%
	111 ↔ 130	RED 100%/GREEN 0%/BLUE DOWN
	131 ↔ 150	RED 100%/GREEN UP/BLUE UP
	151 ↔ 170	RED DOWN/GREEN DOWN/BLUE 100%
	171 ↔ 200	RED 100%/GREEN 100%/BLUE 100%
	201 ↔ 205	WHITE1 : 3200K
	206 ↔ 210	WHITE2 : 3400K
	211 ↔ 215	WHITE3 : 4200K
	216 ↔ 220	WHITE4 : 4900K
	221 ↔ 225	WHITE5 : 5600K
	226 ↔ 230	WHITE6 : 5900K
	231 ↔ 235	WHITE7 : 6500K
236 ↔ 240	WHITE8 : 7200K	
241 ↔ 245	WHITE9 : 8000K	
246 ↔ 250	WHITE10 : 8500K	
251 ↔ 255	WHITE11 : 10000K	
6	000 ↔ 009	NO FUNCTION
	010 ↔ 255	STROBE FROM SLOW TO FAST
7	000 ↔ 009	DIMMING SPEED Return to DIMMER
	010 ↔ 029	OFF (Dimmer speed off)
	030 ↔ 069	DIM1 (Speed 1, the fastest)
	070 ↔ 129	DIM2 (Speed 2)
	130 ↔ 189	DIM3 (Speed 3)
	190 ↔ 255	DIM4 (Speed 4, the slowest)

SPECIAL 1

CHANNEL	VALUE	FUNCTION
1	000↔255	MASTER DIMMER
2	000↔009	NO FUNCTION
	010↔255	STROBE FROM SLOW TO FAST
3	000↔009	DIMMING SPEED RETURN TO DIMMER
	010↔029	OFF (DIMMER SPEED OFF)
	030↔069	DIM1 (SPEED 1, THE FASTEST)
	070↔129	DIM2 (SPEED 2)
	130↔189	DIM3 (SPEED 3)
	190↔255	DIM4 (SPEED 4 ,THE SLOWEST)
4	000↔255	RED (GROUP1)
5	000↔255	GREEN (GROUP1)
6	000↔255	BLUE (GROUP1)
7	000↔255	LIME (GROUP1)
8	000↔255	RED (GROUP2)
9	000↔255	GREEN (GROUP2)
10	000↔255	BLUE (GROUP2)
11	000↔255	LIME (GROUP2)
12	000↔255	RED (GROUP3)
13	000↔255	GREEN (GROUP3)
14	000↔255	BLUE (GROUP3)
15	000↔255	LIME (GROUP3)
16	000↔255	RED (GROUP4)
17	000↔255	GREEN (GROUP4)
18	000↔255	BLUE (GROUP4)
19	000↔255	LIME (GROUP4)
20	000↔255	RED (GROUP5)
21	000↔255	GREEN (GROUP5)
22	000↔255	BLUE (GROUP5)
23	000↔255	LIME (GROUP5)
24	000↔255	RED (GROUP6)
25	000↔255	GREEN (GROUP6)
26	000↔255	BLUE (GROUP6)
27	000↔255	LIME (GROUP6)
28	000↔255	RED (GROUP7)
29	000↔255	GREEN (GROUP7)
30	000↔255	BLUE (GROUP7)
31	000↔255	LIME (GROUP7)
32	000↔255	RED (GROUP8)

33	000↔255	GREEN (GROUP8)
34	000↔255	BLUE (GROUP8)
35	000↔255	LIME (GROUP8)

SPECIAL 2

CHANNEL	VALUE	FUNCTION
1	000↔255	MASTER DIMMER
2	000↔255	RED
3	000↔255	GREEN
4	000↔255	BLUE
5	000↔255	LIME
6	000↔010	NO FUNCTION
	011↔030	RED100%/GREEN UP/BLUE0%
	031↔050	RED DOWN/GREEN100%/BLUE0%
	051↔070	RED0%/GREEN 100%/BLUE UP
	071↔090	RED0%/GREEN DOWN/BLUE 100%
	091↔110	RED UP/GREEN 0%/BLUE 100%
	111↔130	RED100%/GREEN 0%/BLUE DOWN
	131↔150	RED100%/GREEN UP/BLUE UP
	151↔170	RED DOWN/GREEN DOWN/BLUE 100%
	171↔200	RED100%/GREEN 100%/BLUE 100%/LIME 100%
	201↔205	WHITE1 : 3200K
206↔210	WHITE2 : 3400K	
211↔215	WHITE3 : 4200K	
216↔220	WHITE4 : 4900K	
221↔225	WHITE5 : 5600K	
226↔230	WHITE6 : 5900K	
231↔235	WHITE7 : 6500K	
236↔240	WHITE8 : 7200K	
241↔245	WHITE9 : 8000K	
246↔250	WHITE10 : 8500K	
251↔255	WHITE11 : 10000K	
7	000↔009	NO FUNCTION
	010↔255	STROBE FROM SLOW TO FAST
8	000↔009	DIMMING SPEED Return to DIMMER
	010↔029	OFF (Dimmer speed off)
	030↔069	DIM1 (Speed 1, the fastest)
	070↔129	DIM2 (Speed 2)
	130↔189	DIM3 (Speed 3)
	190↔255	DIM4 (Speed 4 ,the slowest)