



创意源于追求
Own Idea Of Lighting

LINX i18

USER MANUAL

arctik[®] LINX i18
ARCHITECTURAL TECHNOLOGY AM725

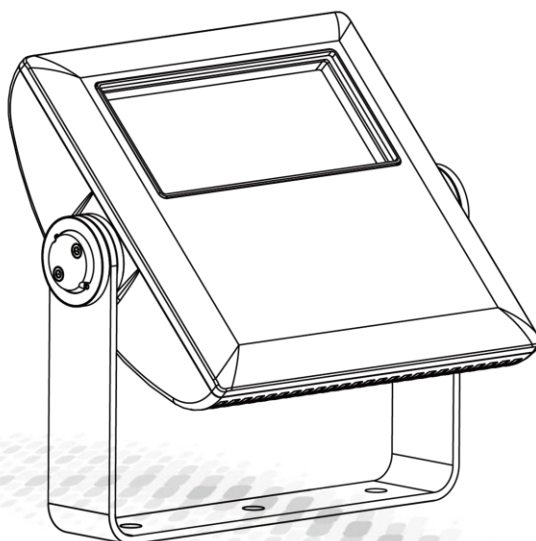

MODEL: AM725SCT/SWT/SNT/SAT



广州市雅江光电设备有限公司
Guangzhou Yajiang Photoelectric Equipment Co., Ltd.
电话/Tel: 020-86947788 邮箱/E-mail: sales@yajiang.cn
传真/Fax: 020-86943773 网址/Website: www.yajiang.cn

1 PRODUCT

1.1 TECHNICAL SPECIFICATIONS

Type	AM725SCT/SWT/SNT/SAT
Power	60W
Voltage Range	AC100-240V,50/60Hz
Protection	IP67
Operation Temperature	-20°C~45°C
Dimensions	305x86x301mm
Weight	6.6kg

DIMENSIONS

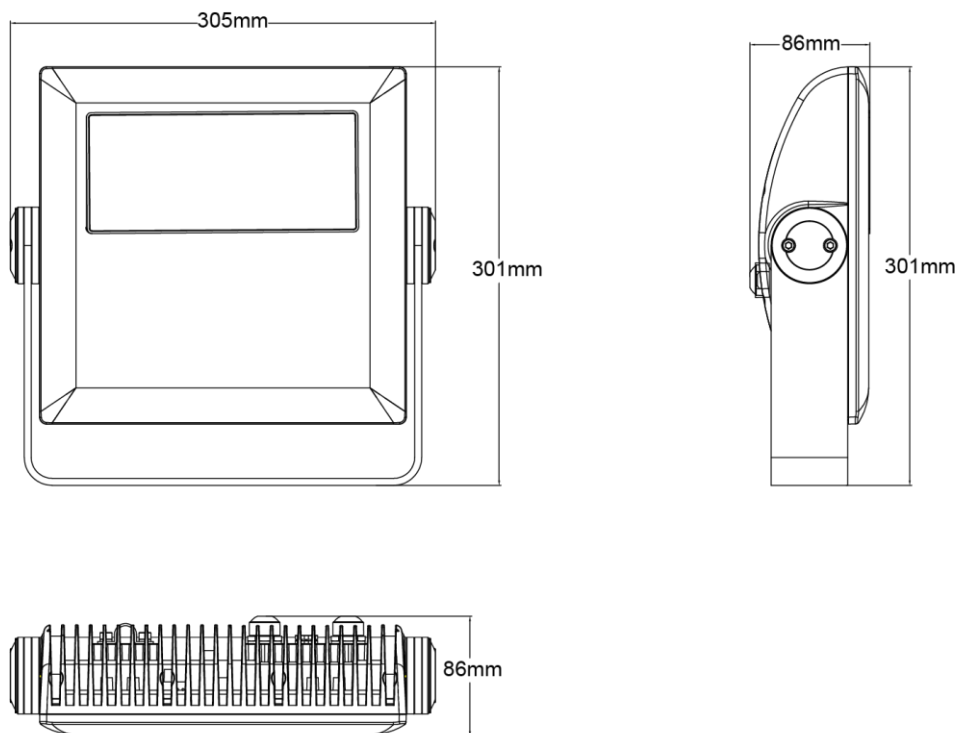

1.2 Safety Notes

IMPORTANT

- This product must be installed by a qualified professional.
- In order to maintain this condition and to ensure safe operation, it is absolutely necessary for the user to follow the safety instructions and warning notes
- The manufacturer will not accept liability for any resulting damages caused by the non-observance of this manual or any unauthorized modification to the device.

CAUTION!

- Make sure that the available voltage is not higher than stated on the rear panel.
- Do not touch the power cables if your hands are wet.
- The earth wire must always be connected to the ground. Therefore it is essential to connect the yellow/green conductor to earth.
- Make sure that the power-cord is never crimped or damaged by sharp edges. Check the device and the power-cord from time to time. The electric connection, repairs and servicing must be carried out by a qualified employee.
- Always disconnect power input cable to completely remove power from unit when not in use or before cleaning or servicing the fixture.
- Do not switch the fixture on and off in short intervals as this would reduce the lamp's life.
- Do not touch the device's housing bare hands during its operation (housing becomes hot)! The surface of the product's casing can reach up to 70° C (158° F) during operation. Avoid contact by persons and materials. Do not install the product in a location where there is a risk of accidental contact. Allow the product to cool for at least 10 minutes before handling.
- For replacement use lamps and fuses of same type and rating only.
- Please protect the fixture and avoid destroy during transport and installation. If there is any damage to the coating, the shell may be corroded.
- When hanging lamps and lanterns, it is necessary to verify that facilities and hooks can bear at least 10 times the weight of lamps and lanterns.
- Fix the safety rope at the correct holes only. Only operate the fixture after having checked that the housing is firmly closed and all screws are tightly fastened.
- The maximum ambient temperature 45°C must never be exceeded. Do not operate the product if the ambient temperature (Ta) exceeds 45° C (115° F).
- The minimum ambient temperature (Ta min.): -40° C.
- When the temperature reaches the above upper limit, the fixture regulates output to protect from overheating.

Electrical Warning

- The light source contained in this luminaire shall only be replaced by the manufacturer or his service agent or a similar qualified person

2 INSTALLATION

2.1 MOUNTING

HANGING

- ◆ You could place the light on the floor. Please make sure the surface is plane and the reliability of the floor is sufficient.
- ◆ Bolt a rigging clamp securely to the mounting yoke. The bolts used must be M12, grade 8.8 steel minimum, and fastened with a self-locking nut.

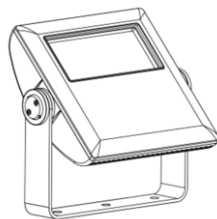

Horizontal layout

2.2 POWER CONNECTIONS

- ◆ This product has an auto-ranging power supply that can work with an input voltage range of 100–240 VAC, 50/60 Hz.

AC Plug

Connection	Wire (U.S.)	Wire(Europe)	Screw Color
AC Live	Black	Brown	Yellow/Brass
AC Neutral	White	Blue	Silver
AC Ground	Green/Yellow	Green/Yellow	Green

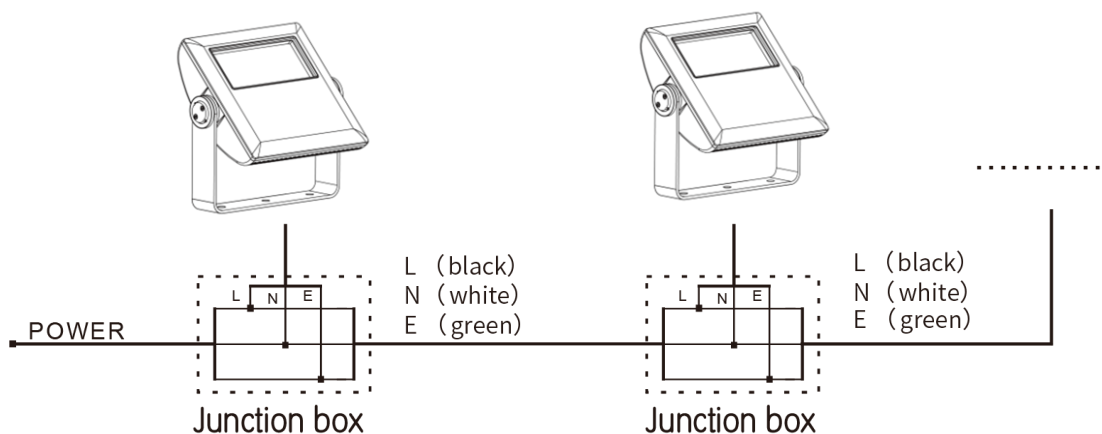

2.3 Data network requirements

- ◆ Connect the DMX512 controller to the units in series. A DMX 512 data link is required in order to control the fixture via DMX. The fixture has 3/5-pin XLR connectors for DMX data input and output.
- ◆ Each unit has 13 DMX channels so the DMX Addresses should increase by increments of 1, (Nx1)+1, (Nx2)+1, (Nx3)+1...
- ◆ Any DMX address in the range from 001 to 512 may be used.

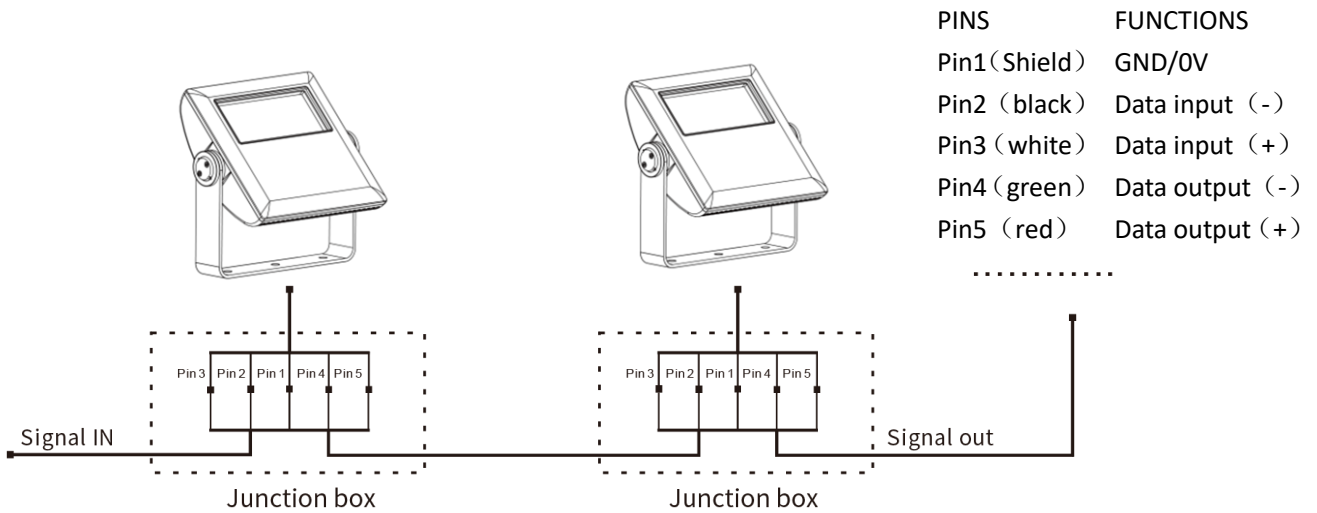

3 USING A DMX512 CONTROLLER

3.1 DMX CONTROL

Note: This product has one DMX512 channel configurations: SOLID

SOLID		
CHANNEL	VALUE	FUNCTION
1	0-255	ALL LED