

F3

FREZNO 150 TW/TC

PRODUCT INTRODUCTION

The FREZNO 150 TW/TC is a compact, lightweight LED Fresnel with high efficiency and CRI. Pure color temperature, built-in 0-100% dimmer, Beam angle 10°-50° (Manual control), Field angle 18°-75°, simple and quick adjustment for choosing beam Angle base to different distances and locations, manual CCT button on body, FREZNO 150 TW with Tunable CCT 2700k-4500k, FREZNO 150 TC with Tunable CCT 4000k-6500k, this model is designed for theater, television, cultural centers, studio, multi-function meeting rooms and other small and medium applications.



PRODUCT PARAMETERS

Optical system

Light source	LED 100W
CCT	TW-3200K(2700K-4500K range) TC-5600K(4000K-6500K range)
CRI	Ra≥95
CQS	>90
Beam angle	10°-50° (Manual control)
Field angle	18°-75°

Appearance

Size	321x274x363mm
Weight	5.3kg
Casing	Die-cast aluminum
Color	Black

Electrical Specs

Voltage	AC100-240V, 50/60Hz
Max. Power	120W
Power Connection	Power in and out
DMX XLR	3pin or 5pin in and out

Control System

Dimmer	0-100% 16Bit
Cooling	Forced Convection
Control	DMX512, RDM
Display	On board Control , Custom Mode , 0-25Hz Strobe, Dimming knob

Con Personality UNO/1CHS, DOS/2CHS, VW.D/3CHS, VW.F/6CHS, STD.P/8CHS

Certification

CE, MET

Work Environment

Ambient Temp 0°C-45°C
IP Rated IP20

ILLUMINANCE AT DISTANCE

SS816TW

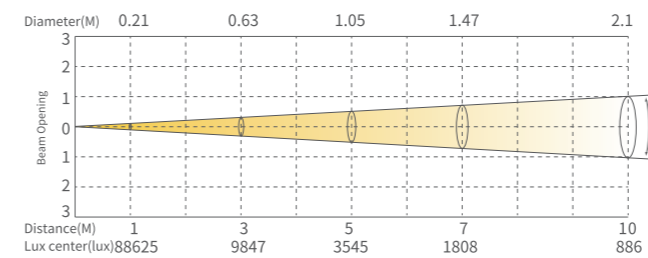

SS816TC

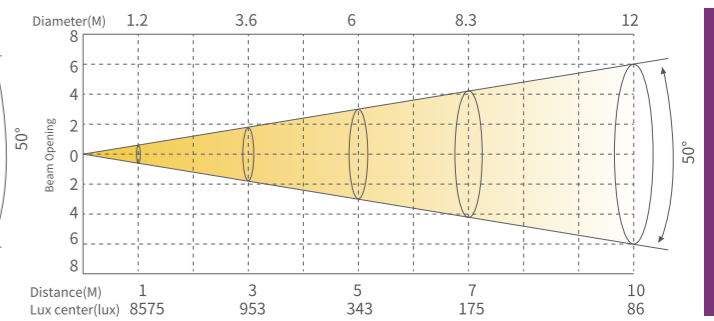
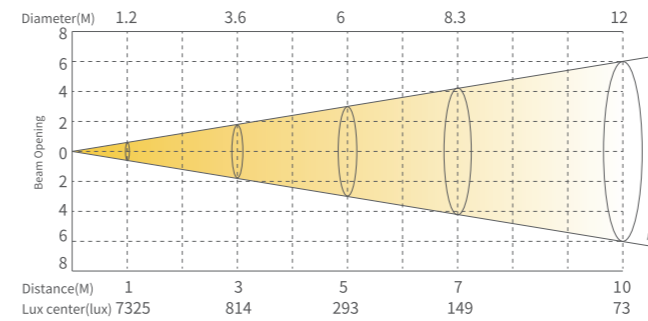
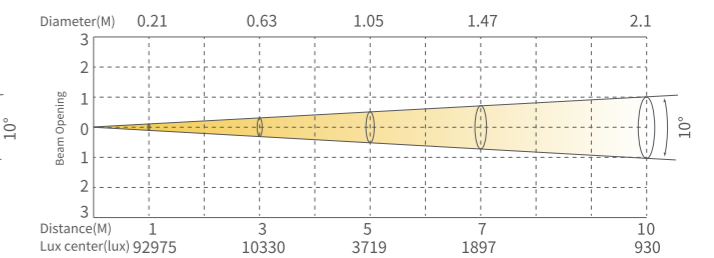

DIMENSIONS

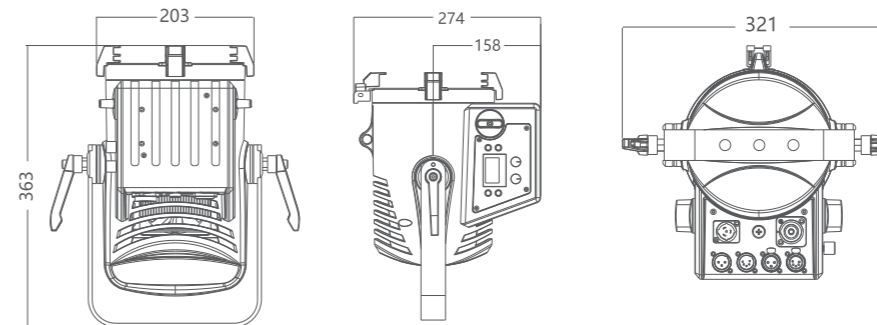

ACCESSORIES (Accessories not included unless otherwise stated)

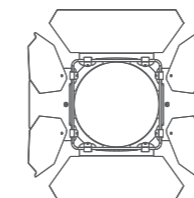

Barn doors
(2440010677, 6813000324)

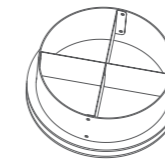

Short hat
(2440501465)